

Powerex, Inc., 173 Pavilion Lane, Youngwood, Pennsylvania 15697 (724) 925-7272
www.pwr.com

POW-R-BLOK™ Dual Diode Isolated Module Up to 320 Amperes & 2000 Volts

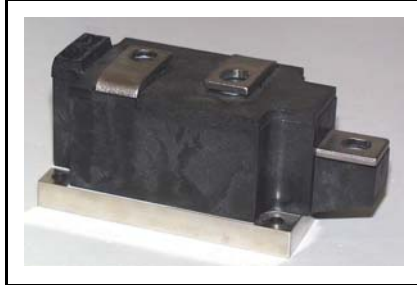
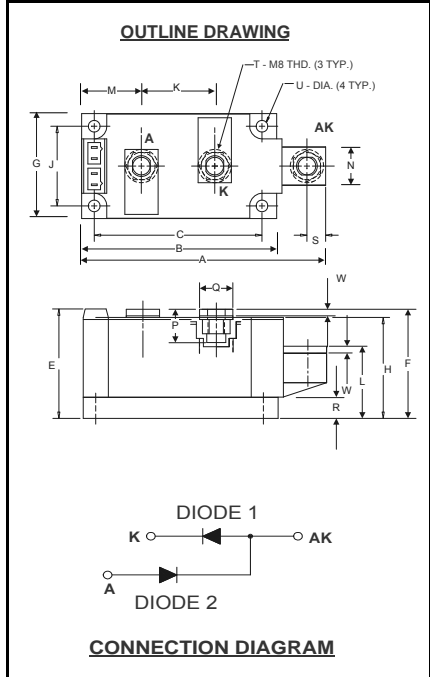

ND41__32
Dual Diode Isolated
POW-R-BLOK™ Module
200-320 Amperes / 600-2000 Volts

Description:

Powerex Dual Diode Modules are designed for use in applications requiring rectification and isolated packaging. The modules are isolated for easy mounting with other components on a common heatsink. *POW-R-BLOK™* has been tested and recognized by the Underwriters Laboratories.

Features:

- Electrically Isolated Heatsinking
- Aluminum Nitride Isolator
- Compression Bonded Elements
- Metal Baseplate
- Low Thermal Impedance for Improved Current Capability
- UL Recognized

Benefits:

- No Additional Insulation Components Required
- Easy Installation
- No Clamping Components Required
- Reduce Engineering Time

Applications:

- Bridge Circuits
- AC & DC Motor Drives
- Battery Supplies
- Power Supplies
- Large IGBT Circuit Front Ends

ND41 Outline Dimensions

Dimension	Inches	Millimeters
A	4.57	116
B	3.66	93
C	3.15	80.0
E	2.06	52.3
F	2.05	52.0
G	1.97	50.0
H	1.90	48.3
J	1.50	38.1
K	1.38	35.0
L	1.26	32.0
M	1.122	28.5
N	.71	18.0
P	.57	14.5
Q	.625	15.9
R	.394	10.00
S	.350	8.9
T	M8 Metric	M8
U	.250 Dia.	6.35 Dia.
W	.12	3.0

Note: Dimensions are for reference only.

Ordering Information:

Select the complete eight digit module part number from the table below.

Example: ND412032 is a 2000Volt, 320 Ampere Dual Diode Isolated *POW-R-BLOK™* Module

Type	Voltage Volts (x100)	Current Amperes (x10)
ND41	06 08 10 12 14 16 18 20	32

Absolute Maximum Ratings

Characteristics	Conditions	Symbol		Units
Repetitive Peak Reverse Blocking Voltage		V_{RRM}	up to 2000	V
Non-Repetitive Peak Reverse Blocking Voltage ($t < 5$ msec)		V_{RSM}	$V_{RRM} + 200$	V
RMS Forward Current	180° Conduction, $T_C=101^\circ\text{C}$	$I_{F(RMS)}$	502	A
	180° Conduction, $T_C=105^\circ\text{C}$	$I_{F(RMS)}$	470	A
	180° Conduction, $T_C=109^\circ\text{C}$	$I_{F(RMS)}$	440	A
	180° Conduction, $T_C=112^\circ\text{C}$	$I_{F(RMS)}$	408	A
Average Forward Current	180° Conduction, $T_C=101^\circ\text{C}$	$I_{F(AV)}$	320	A
	180° Conduction, $T_C=105^\circ\text{C}$	$I_{F(AV)}$	300	A
	180° Conduction, $T_C=109^\circ\text{C}$	$I_{F(AV)}$	280	A
	180° Conduction, $T_C=112^\circ\text{C}$	$I_{F(AV)}$	260	A
Peak One Cycle Surge Current, Non-Repetitive Initial $T_j = T_j$ max	60 Hz, 100% V_{RRM} reapplied	I_{FSM}	8000	A
	60 Hz, No V_{RRM} reapplied	I_{FSM}	10,000	A
Peak Three Cycle Surge Current, Non-Repetitive	60 Hz, 100% V_{RRM} reapplied	I_{FSM}	5750	A
Peak Ten Cycle Surge Current, Non-Repetitive	60 Hz, 100% V_{RRM} reapplied	I_{FSM}	4975	A
I^2t for Fusing for One Cycle, 8.3 milliseconds		I^2t	266,000	$\text{A}^2 \text{ sec}$
Operating Temperature		T_J	-40 to +150	$^\circ\text{C}$
Storage Temperature		T_{stg}	-40 to +150	$^\circ\text{C}$
Max. Mounting Torque, M6 Mounting Screw			45	in.-Lb.
			5	Nm
Max. Mounting Torque, M8 Terminal Screw			95	in.-Lb.
			11	Nm
Module Weight, Typical			840	g
			1.85	lb.
V Isolation @ 25C		V_{rms}	2500	V

Electrical Characteristics, T_J=25°C unless otherwise specified

Characteristics	Symbol	Test Conditions	Min.	Max.	Units
Repetitive Peak Reverse Leakage Current	I _{RRM}	Up to 2000V, T _J =150°C		50	mA
Peak On-State Voltage	V _{FM}	I _{FM} =1500A		1.35	V
Threshold Voltage, Low-level	V _{(TO)1}	T _J = 150°C, I = 15%I _{F(AV)} to πI _{F(AV)}		0.764	V
Slope Resistance, Low-level	r _{T1}			0.360	mΩ
Threshold Voltage, High-level	V _{(TO)2}	T _J = 150°C, I = πI _{F(AV)} to I _{FSM}		0.710	V
Slope Resistance, High-level	r _{T2}			0.420	mΩ
V _{TM} Coefficients, Full Range		T _J = 150°C, I = 15%I _{F(AV)} to I _{FSM} V _{FM} = A+ B Ln I + C I + D Sqrt I	A = B = C = D =	0.7144 0.0232 4.72 E-4 -6.71 E-3	
Diode Reverse Recovery Time (Typical)	t _{rr}	I _{fm} = 1500A, T _p = 190 μs di/dt = -25A/μs		10	μs

Thermal Characteristics

Characteristics	Symbol		Max.	Units
Thermal Resistance, Junction to Case	R _{ΘJ-C}	Per Module, both conducting Per Junction both conducting	0.07 0.14	°C/W °C/W
Thermal Impedance Coefficients	Z _{ΘJ-C}	Z _{ΘJ-C} = K ₁ (1-exp(-t/τ ₁)) + K ₂ (1-exp(-t/τ ₂)) + K ₃ (1-exp(-t/τ ₃)) + K ₄ (1-exp(-t/τ ₄))	K ₁ = 5.27E-3 K ₂ = 1.17E-2 K ₃ = 5.26E-2 K ₄ = 6.97E-2	τ ₁ = 1.69E-4 τ ₂ = 2.07E-2 τ ₃ = 2.37E-1 τ ₄ = 2.46
Thermal Resistance, Case to Sink Lubricated	R _{ΘC-S}	Per Module	0.03	°C/W

Powerex, Inc., 173 Pavilion Lane, Youngwood, Pennsylvania 15697 (724) 925-7272
www.pwr.com

POW-R-BLOCK™ Dual Diode Isolated Module Up to 320 Amperes & 2000 Volts

Maximum On-State Forward Voltage Drop
(T_J = 150 °C)

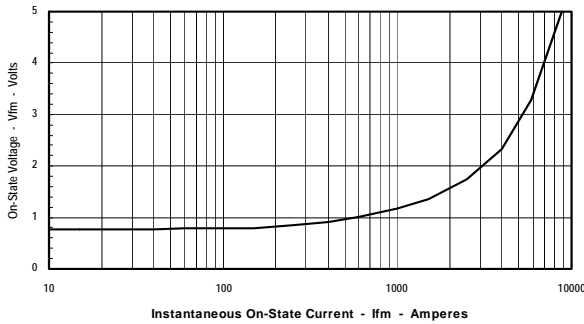

Maximum Transient Thermal Impedance
(Junction to Case)

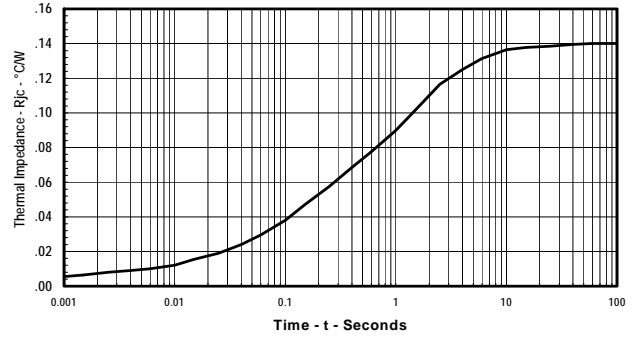

Maximum On-State Power Dissipation
(Sinusoidal Waveform)

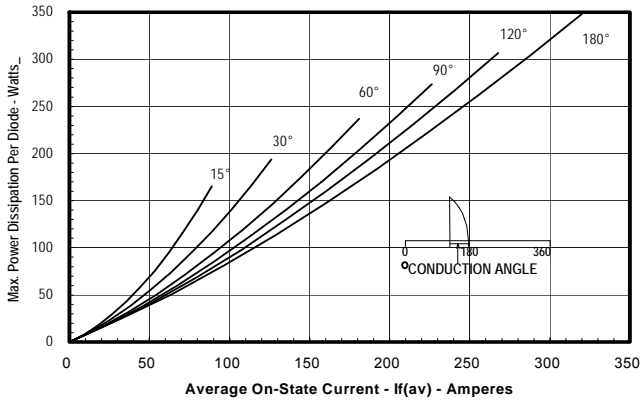

Maximum Allowable Case Temperature
(Sinusoidal Waveform)

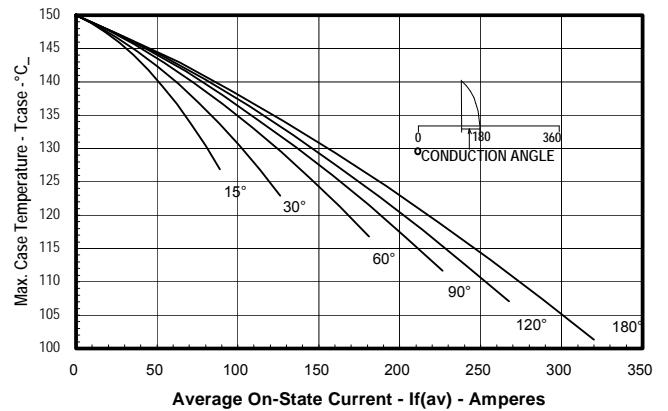

Maximum On-State Power Dissipation
(Rectangular Waveform)

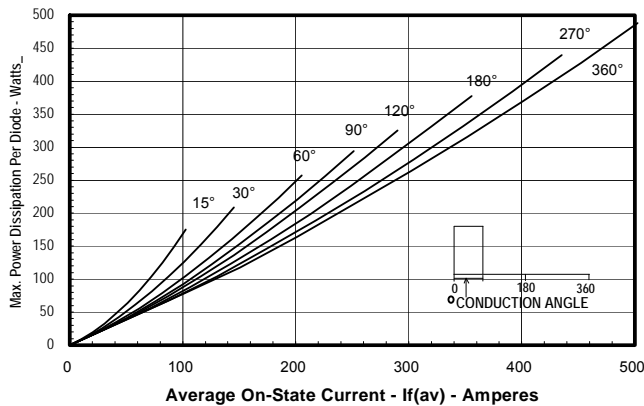

Maximum Allowable Case Temperature
(Rectangular Waveform)

